



Trijicon RMR® HD



The Trijicon RMR® HD is an innovative red dot pistol optic specifically designed for the evolving needs of Law Enforcement and the Military. Built on the foundation of the Trijicon RMR® Adjustable LED model, the RMR HD features the same patented housing shape made from forged aluminum, robust electronic system, and quality lenses. Adding a long-lasting, top-loading battery, larger window, an innovative forward looking light sensor, multiple reticle options, market leading illumination adjustability, and it's clear the RMR HD is designed and built for duty use.

The innovative forward looking light sensor gauges the brightness at target in auto mode and adjusts reticle brightness to be effective in any lighting scenario. A new reticle allows you to switch between a complex reticle or single crisp dot, both of which include a new super bright setting and an additional night vision setting. The RMR HD also allows the operator to adjust the Auto Illumination as well as the dot/circle contrast. Additional features include larger, more tactile buttons, new adjusters with greater audible and tactile feedback, and an expanded field of view. Offering the same footprint as the RMR and designed to fit most existing optics-ready duty holsters*, the Trijicon RMR HD is ready for those needing a feature-rich optic with high performance and ultra-reliability.

Ready for Duty

- 1 Convenient**
 - Uses the same footprint as the RMR®
 - Uses common top-loading CR2032 battery
 - Designed to fit current duty holsters*
- 2 Durable**
 - RMR-style patented shape diverts the force of impact, for use in the harshest conditions
 - Waterproof up to 66 ft. / 20m
 - 7075 T-6 forged aluminum housing
- 3 Dynamic**
 - Switch between center dot only or full reticle
 - New light sensor adjusts dot brightness to target environment
 - Customizable auto-brightness range can be tuned to user preference
 - Nine brightness settings controlled by more responsive buttons

The Science of Brilliant®

At Trijicon, we are bound by a commitment to industry-leading research, design, and testing to seek innovative aiming solutions that constantly redefine "brilliant." That's why Trijicon products are subjected to the below testing methods.



Alaska-to-Africa Tested | Solid Zero Tested | Drop Tested
Vibration Tested | Immersion Tested

Visit Trijicon.com/Science to learn more.

* May not fit every duty holster

Features and Benefits



- A Top-Loading Battery**
Battery changes are easy, with no need to dismount the optic; Uses common CR2032 battery, providing up to four years of battery life.
- B Upgraded Windage & Elevation Adjusters**
More tactile and audible clicks for tool-less zeroing.
- C Rugged, Durable Construction**
7075-T6 forged aluminum housing; waterproof up to 66 ft. (20 m).
- D Large, Unobstructive Field of View**
Find the reticle with ease; parallax free.
- E Reliability for Everyday Carry**
Unique shape diverts impact force to protect lens from drops and bumps.
- F Complete User-Control Illumination Settings**
Nine brightness settings with multiple modes for excellent visibility in any lighting condition.
- G Clear Target Visibility**
Advanced lens technology provides crisp field of view.
- H Identical Footprint as RMR®**
Mounts easily on popular red-dot-ready pistols using the same base as Trijicon RMR®.
- I Improved Controls**
More tactile and audible controls provide positive feedback when used with duty gloves.
- J Index Ridge Alignment Aid**
Unique housing design provides built-in index point for fast sight picture acquisition even from atypical positions.
- K New Night Vision Settings**
Three total night vision settings for use with any generation night vision system.

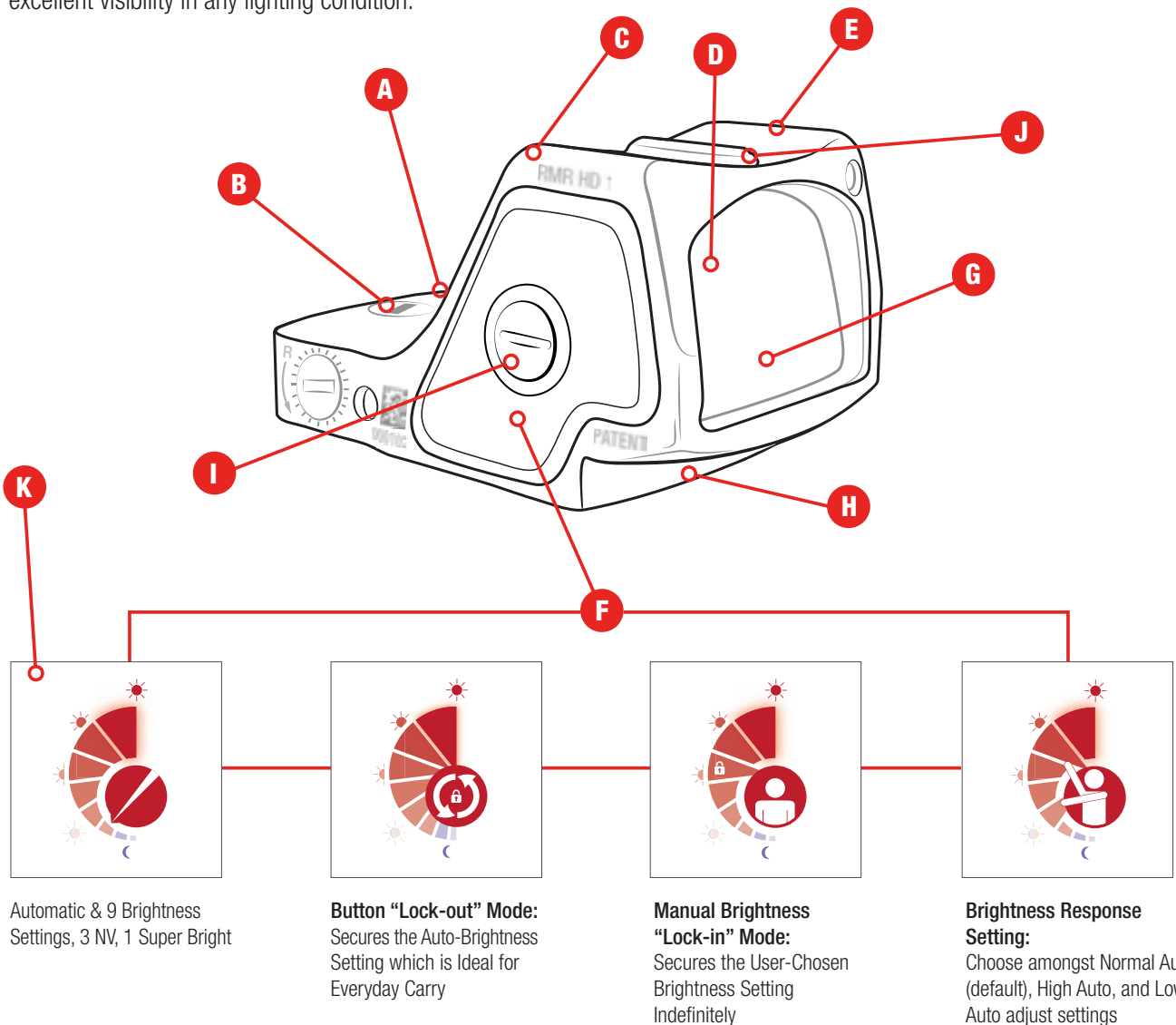

Forward-Mounted Light Sensor



The new forward-mounted light sensor enables the RMR HD Automatic Brightness mode to read the lighting conditions at the target, rather than just at the user. No longer worry about “reticle washout” when engaging targets from a dimly lit space out to a brightly lit area — or “reticle bloom” when the shooting position is reversed. The LED intensity in the RMR HD automatically responds to the lighting conditions forward of the objective lens, providing an optimal aiming point.

- New light sensor design adjusts reticle illumination to target lighting conditions in auto mode, delivering a situationally ideal reticle brightness level.
- Enhanced technology improves dynamic performance in changing lighting conditions, e.g., activation/deactivation of weapon-mounted lights.

Target in bright light, User in low light

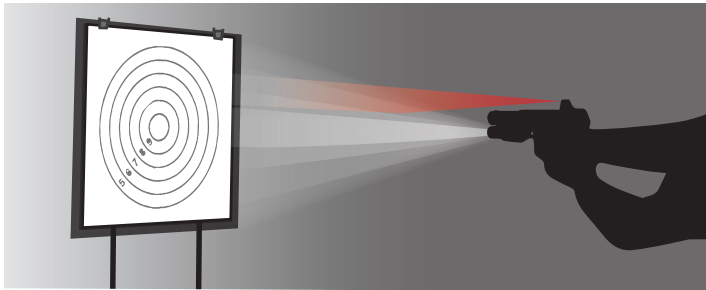

Target area is light and the illumination setting is too dim for the user to see.

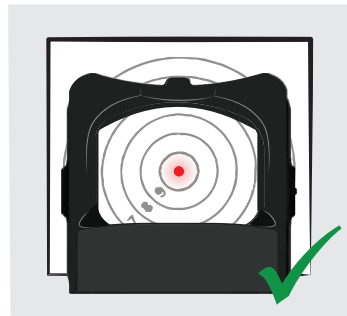

The RMR HD light sensor reads the target area and provides an optimal aiming point.

Target in low light, User in bright light

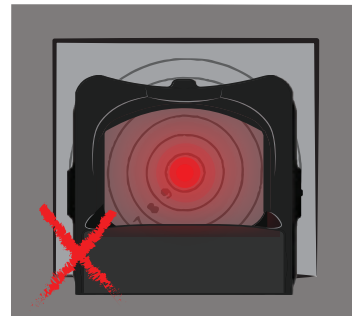
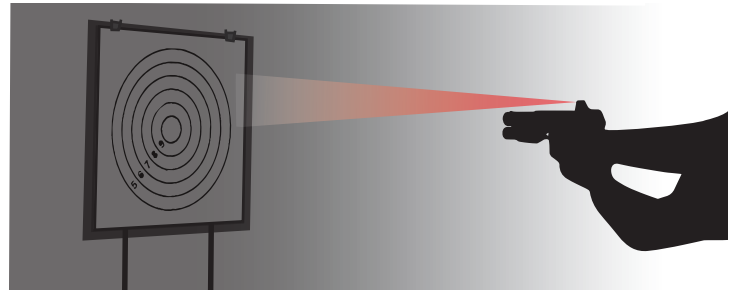

Target area is dark, but the illumination setting for the reticle is much too bright, obscuring shooter's target.

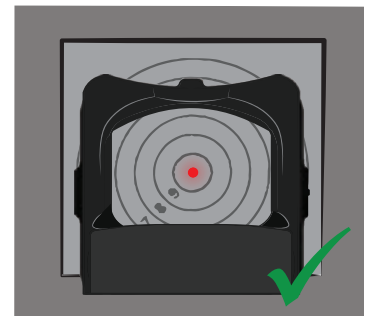

The RMR HD light sensor reads the target area and provides an optimal aiming point.

Specifications

Magnification	1x
Sight Window	0.89 x 0.67 in. 22.6 x 17.2mm
Lens	Tempered Glass
Adjustments	1 click = 1 MOA
Adjustment Range (Elevation & Windage)	135 MOA Total Travel

Dimensions (L x W x H)	2.15 x 1.27 x 1.19 in. 54.6 x 32.3 x 30.2mm
Weight	1.69 oz. (w/ battery) 47.8g
Illumination Source	LED Powered by CR2032 Battery
Battery Life*	Over 3 years of continuous use at dot-only setting “5” (of 9) at 70°F (21°C)
Brightness Settings	Automatic & 9 Brightness Settings, 3 NV, 1 Super Bright

**Extreme temperatures (high or low) will affect lithium battery performance.*

Reticle Options

Choose either 1.0 MOA or 3.25 MOA center dot model. Both models feature a 55 MOA ring reticle that the user can toggle on or off.

RMR HD 01

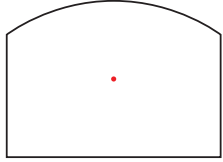

1.0 MOA Center Dot Only

RMR HD 02

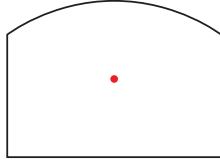

3.25 MOA Center Dot Only

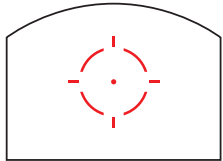

55 MOA Segmented Circle with 1.0 MOA Center Dot

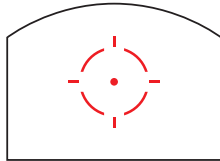

55 MOA Segmented Circle with 3.25 MOA Center Dot

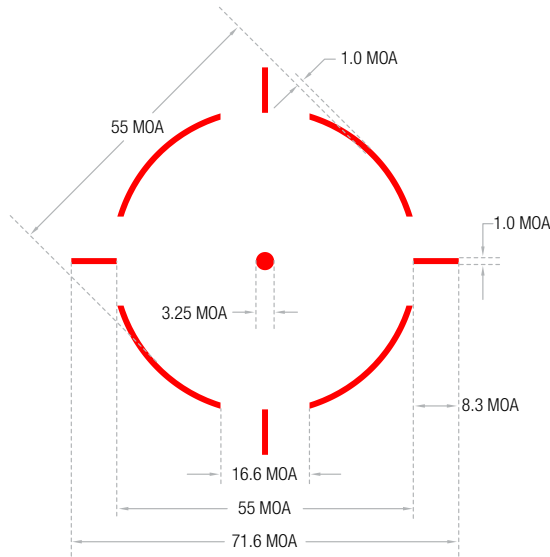

NOTE: Reticles not shown to scale.

Size Comparison



Holster Compatibility



Scan the QR Code to see the most up-to-date list of compatible holsters that work with the Trijicon RMR HD or visit:

[Trijicon.com/HolsterCompatibility](https://www.trijicon.com/HolsterCompatibility)

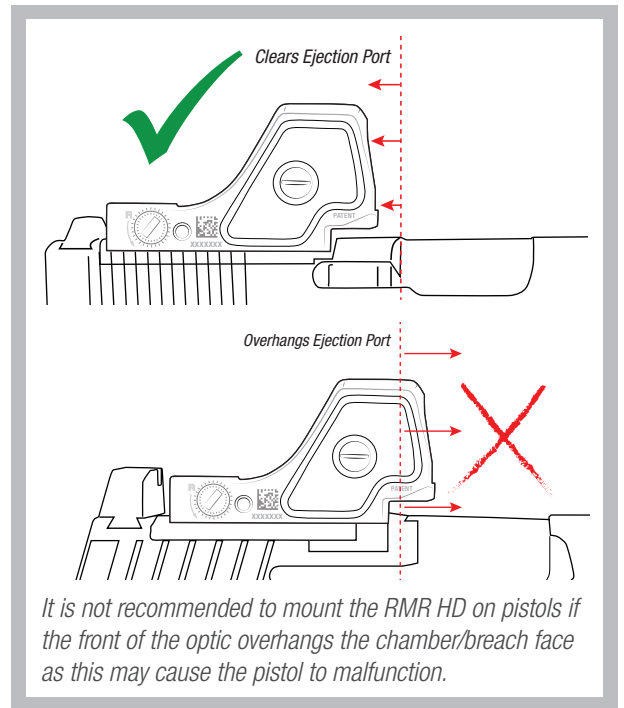

It is not recommended to mount the RMR HD on pistols if the front of the optic overhangs the chamber/breach face as this may cause the pistol to malfunction.



[Trijicon.com/RMRHD](https://www.trijicon.com/RMRHD)

©2023 Trijicon, Inc. | Wixom, Michigan USA | Phone: 1-800-338-0563 | info@trijicon.com
Specifications subject to change without notice. | PML4090 Rev(1) 0623